

(Not suitable for children under 14 years old)
(Please read through this manual before use)

Sea-god 6

2.4GHz remote control karting boat



(Instruction manual)

1. Frequency matching: Connect the battery to the ship with the correct polarity, and the ship makes a sound. Press the power switch on the remote control, and the indicator light on the remote control will remain on. Frequency matching is successful. (If the remote device fails to match the frequency, the indicator light will flash)
2. Do not pilot the boat more than 50m away from the remote control, otherwise connection will be lost.
3. When the speed of the ship slows down obviously in the course of driving it may be that the power is low, please bring it back within range in time or it may drain the battery in places you cannot reach.
4. The boat does not have a self-righting function, so take care not to flip it or crash into obstacles during operation.
5. Avoid aquatic plants during operation, as these may get entangled with the propeller.
6. Fine adjust the direction of the remote control to control left and right deviation.
7. Low battery prompt: When the battery of the remote control ship is low, the lights of the remote control ship and remote control will flash, and the remote control will sound a chime and repeat the prompt; When the battery of the remote control is low, the remote control light flashes and there is no phoenix sound prompt. Please recharge the battery or replace it with a new one.

◎ Name of each component

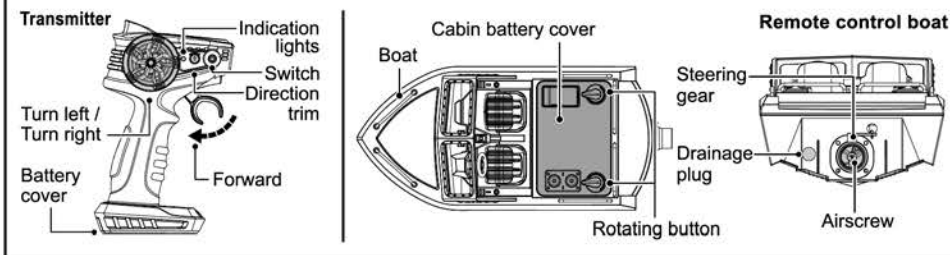

◎ Battery charging method and installation

① Battery charging method

- (1). Insert the USB charging cable into the USB socket of the computer (as shown in the figure), and the USB charging cable power indicator light will turn on red.
- (2). The charging time is about 90 minutes. When charging, the red indicator light lights up, and after charging is completed, the red indicator light goes out.

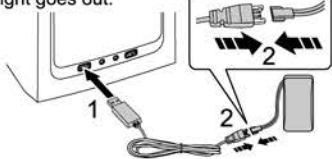

② Installing the battery pack

- (1). Rotate the knob in the direction indicated by the arrow and release the cabin battery cover.

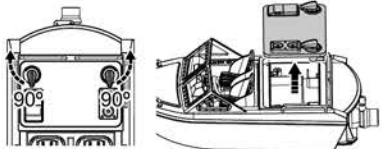

- (2). Place the battery in its position inside the hull and ensure that it does not shake. Connect the battery to the socket on the receiver according to the correct polarity. Install the battery cover in the cabin and lock it with a rotating button. (After the power is connected, the cabin makes a sound)

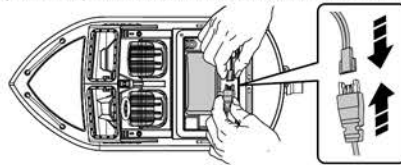

③ Remote control battery installation

Open the battery cover of the remote control, install 2 x 1.5V "AA" batteries in the positive and negative directions (to be purchased separately), and close the battery cover.

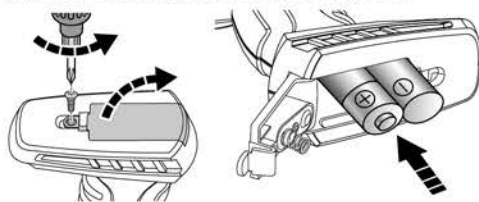

◎ Installation of accessory parts

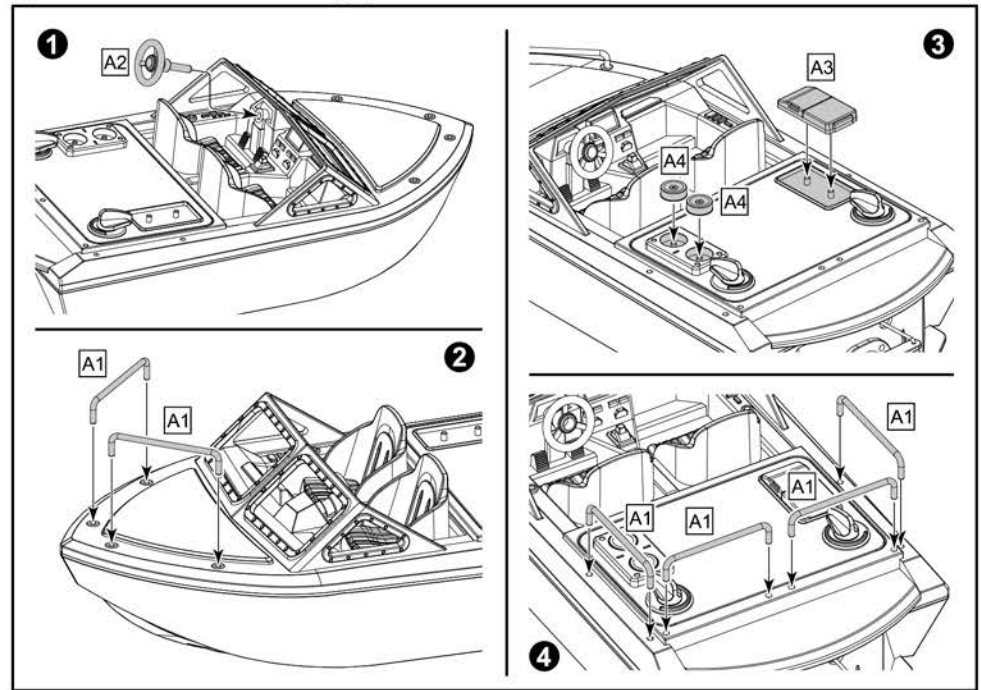

◎ Function

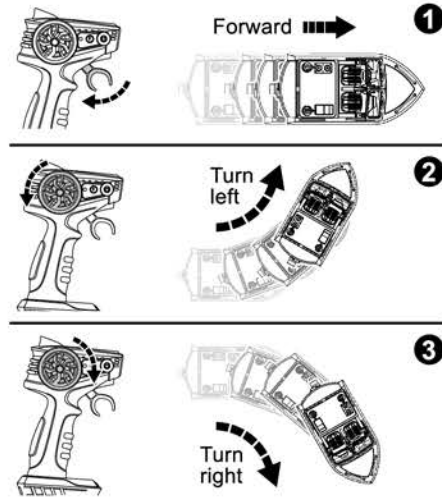

④ Direction trim

- (1). When the ship is moving forward, turn to the left and slightly adjust the direction clockwise until the ship travels in a straight line.
- (2). When the ship is moving forward, turn to the right and slightly counterclockwise to adjust the direction until the ship travels in a straight line.

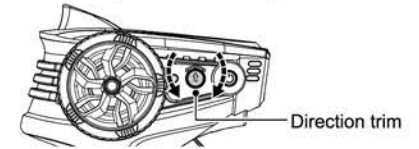

⑤ Remote control prompt function

When the distance is exceeded and the signal is lost, the remote control will sound two chimes, the remote control light will synchronize with the chime and repeat the prompt, and the ship's indicator light will flash. Please return immediately. During the return journey, the remote control and the ship will still issue a prompt. The prompt will not disappear until the signal stabilizes

◎ Product maintenance

After using the ship, the hatch cover should be removed, the batteries inside the ship should be removed, and there should be no water ingress inside the ship. If any, please wipe off the water droplets and let them dry for a period of time before covering the cabin cover to prevent damage to internal electronic parts. Next time you use it, fix the fully charged battery on the battery rack and connect it to the power source for use.